



Main Features

- For corrosive gasses and liquids
- Class 1 and 2 according to EN 13190
- Wetted parts Stainless steel
- Option : case material 1.4404 (316L) for aggressive atmosphere

Applications

- Food & Beverage
- Oil & Gas / Chemical
- Water & Waste water
- Energy
- Machinery

Technical Data

Nominal size	80, 100, 130, 160 mm
Temperature ranges	-70 ... 600°C / -100 ... 1100°F
Accuracy	According to EN 13190 up to 250°C: class 1 above 250°C: class 2 (class 1 on request)
Protection rating	IP 67 (EN 60529)
Immersion tube	Stainless steel 1.4571 (AISI 316Ti)
Case	Stainless steel 1.4301 (AISI 304)
Bezel ring	Stainless steel 1.4301 (AISI 304)
Window	Instrument glass
Window gasket	Elastomer

Dial	Aluminium, white
Pointer	Aluminium, black, adjustable
Minimum immersion length	Immersion tube Ø 6 mm: L2 ≥ 65 mm Immersion tube Ø 8 mm: L2 ≥ 50 mm
Temperature limit	ranges ≤ 400°C: 135% F.S. ranges > 400°C: 100% F.S.
ATEX	Ex II2GDc (with option 0078)

Options

ATEX II2GDc (Including window laminated safety glass)	Code 0078
Stainless steel housing 1.4404 (316L) ⁽¹⁾	Code 0110
Dampening grease	Code 0581
Zero adjustment by knob on the backside ⁽²⁾	Code 0727
Laminated safety glass	Code 0751
Acrylic glass (PMMA or Plexiglass) ⁽³⁾	Code 0752
Window polycarbonate ⁽⁴⁾	Code 0753
Silicon free, label marking	Code 0793
Silicon free, marking on dial	Code 0794
Customer specific immersion length ⁽⁵⁾	Code 9003_xxxx
Red mark	Code 9700
Specific temperature range	Code 9704
Customer logo on dial	Code 9710
Specific technical data on dial	Code 9711

⁽¹⁾ Only NS 100 and NS 130.

⁽²⁾ Only center back and every angle.

⁽³⁾ The case must not be constantly heated over 75°C.

⁽⁴⁾ Only center back and every angle, not for NS 160.

⁽⁵⁾ xxxx = L1 in mm.

Additional ordering codes for specific process connections	Sliding	Fix
G ¼" male	9550	9551
¼" - 18 NPT male	9560	9561
¾" - 14 NPT male	9562	9563
1" - 11.5 NPT male	9564	9565
M18 x 1.5 male	9574	9575
M27 x 2.0 male	9576	9577
M20 x 1.5 female	9584	-
M24 x 1.5 female	9586	-

To be used with ordering code = 0 for specific connection
Example: TBI 100 204.162.12T / **9550**

To be ordered separately

Material certificate 3.1 EN 10204	90001132
Calibration certificate (3 points)	90001188

Drawing - Immersion tube bottom (dimensions in mm)

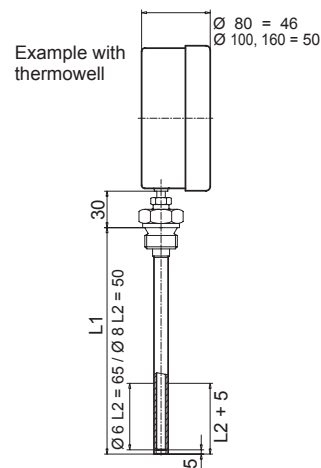
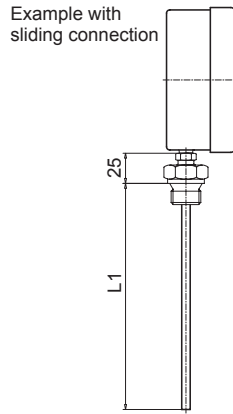
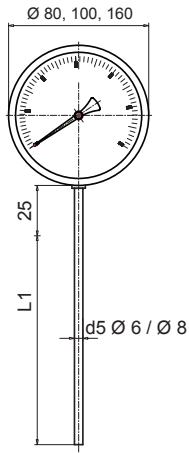

NS	Weight (kg)
80	0.250
100	0.300
160	0.700
Add per 100 mm	
Ø 6 mm	0.007
Ø 8 mm	0.017

Drawing - Immersion tube center back (dimensions in mm)

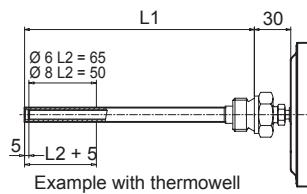
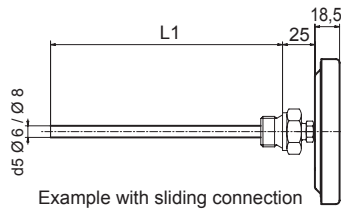
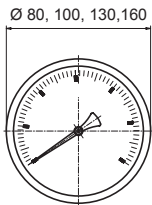

NS	Weight (kg)
80	0.110
100	0.160
130	0.300
160	0.450
Add per 100 mm	
Ø 6 mm	0.007
Ø 8 mm	0.017

Drawing - Immersion tube center back, every angle (dimensions in mm)

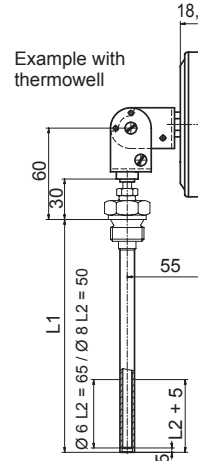
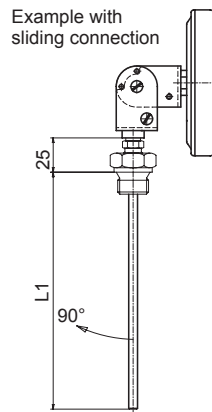
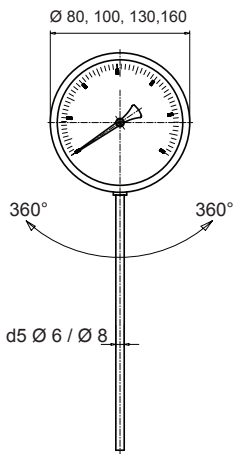

NS	Weight (kg)
80	0.300
100	0.350
130	0.470
160	0.610
Add per 100 mm	
Ø 6 mm	0.007
Ø 8 mm	0.017

Drawings - connections

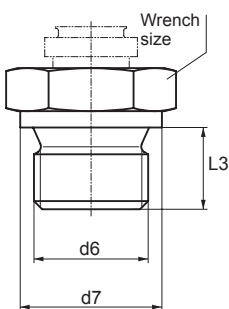

Cylindrical screw threads

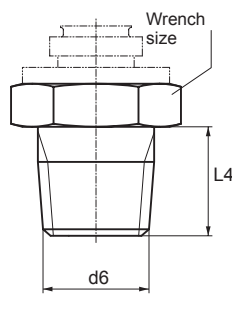

Conical screw threads

d6	d7	L3	L4	Wrench size	Weight (kg)	
					sliding	fix
G 1/2", male	26	15	-	27	0.095	0.090
G 3/4", male	32	16	-	32	0.150	0.140
G 1", male	39	19	-	41	0.210	0.240
M 20 x 1.5, male	27	14	-	27	0.090	0.090
M 24 x 1.5, male	27	15	-	27	0.110	0.110
1/2" - 14 NPT", male	-	-	20	27	0.095	0.100

Temperature ranges

Code	Range °C
53T ¹⁾	-10 ... 30
52T	-20 ... 40
54T	-20 ... 60
84T	-20 ... 100
55T	-30 ... 170
51T	-30 ... 70
68T	-70 ... 50
10T ¹⁾	0 ... 40
11T	0 ... 60
27T	0 ... 80
12T	0 ... 100
20T	0 ... 120
13T	0 ... 160
22T	0 ... 200
14T	0 ... 250
23T	0 ... 300
15T	0 ... 400
25T	0 ... 500
16T	0 ... 600
30T	100 ... 500

Code	Range °F
68U	-100 ... 120
09U	-50 ... 120
08U	-40 ... 160
54U	0 ... 140
02U	0 ... 200
03U	0 ... 250
04U	0 ... 300
05U	0 ... 400
06U	0 ... 500
11U	30 ... 140
20U	30 ... 250
13U	30 ... 320
22U	30 ... 400
23U	30 ... 580
15U	30 ... 750
28U	100 ... 800
29U	200 ... 1000

Code	Range (double scale) °C / °F
51V	-30 ... 70 / -40 ... 160
68V	-70 ... 50 / -100 ... 100
55V	-30 ... 170 / 0 ... 350
11V	0 ... 60 / 30 ... 140
20V	0 ... 120 / 30 ... 250
13V	0 ... 160 / 30 ... 320
14V	0 ... 250 / 30 ... 500
15V	0 ... 400 / 30 ... 750
16V	0 ... 600 / 100 ... 1100

¹⁾ Only center back version, NS 80 and NS 100, max. immersion length 160 mm

Ordering example with options

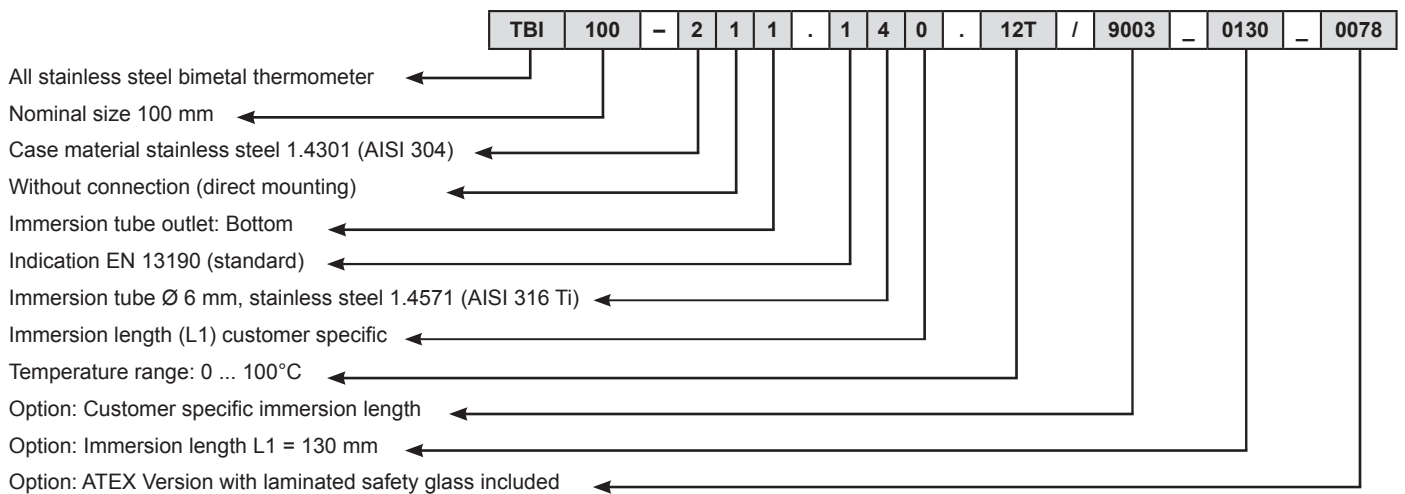

Ordering details TBI

	TBI			-	2			.	1		.	xxx	/
Model	TBI												
All stainless steel Industrial Bimetal Thermometer													
Nominal size													
80 mm		0	8	0									
100 mm		1	0	0									
130 mm		1	3	0									
160 mm		1	6	0									
Case													
Stainless steel 1.4301 (AISI 304)					2								
Connection													
Without connection (direct mounting)													1
With sliding connection:													
Sliding screw connection M20 x 1.5, male ⁽³⁾													2
Sliding screw connection M24 x 1.5, male ⁽³⁾													3
Sliding screw connection G 1/2", male ⁽³⁾													5
Sliding screw connection 1/2"-14 NPT, male ⁽⁴⁾													6
Sliding screw connection G 3/4", male ⁽³⁾													7
Sliding screw connection G 1", male ⁽³⁾													8
Sliding screw connection G 1/2", female													9
Sliding screw connection G 3/4", female													A
Sliding screw connection G 1", female													B
With fix connection: ⁽¹⁾													
Fix screw connection G 1/2", male ⁽¹⁾⁽⁵⁾													C
Fix screw connection G 3/4", male ⁽¹⁾⁽⁵⁾													D
Fix screw connection G 1", male ⁽¹⁾⁽⁵⁾													E
Fix screw connection M20 x 1.5, male ⁽¹⁾⁽⁵⁾													S
Fix screw connection M24 x 1.5, male ⁽¹⁾⁽⁵⁾													T
Fix screw connection 1/2"-14 NPT, male ⁽¹⁾⁽⁶⁾													Q
Specific connection (additional code needed, see page 1)													0
Immersion tube outlet													
Bottom													1
Center back													2
Center back, every angle													4
Indication													
EN 13190 (Standard)													1
Immersion tube / diameter / material													
Ø 6 mm, stainless steel 1.4571 (AISI 316 Ti)													4
Ø 8 mm, stainless steel 1.4571 (AISI 316 Ti)													6
Immersion tube / installed length L1													
60 mm ⁽²⁾													1
100 mm													2
160 mm													4
250 mm													6
400 mm													7
600 mm													8
1000 mm													9
Customer specific length (use option 9003_ xxxx, xxxx = L1 in mm)													0
Unit of measurement / Temperature ranges ⁽⁷⁾													
°C													xxT
°F													xxU
°C / °F (double scale)													xxV
Options to be added behind the / (see example page 3)													/

⁽¹⁾ TBI with fix connection: only available for the every angle version of TBI

⁽²⁾ L1 < 100 mm: only for immersion tube Ø 8 mm and only for temperature ≤ 250°C. The case must not be heated over 110°C.

⁽³⁾ Form 2 according to EN 13190

⁽⁴⁾ Form 6 according to EN 13190

⁽⁵⁾ Form 3 according to EN 13190

⁽⁶⁾ Form 7 according to EN 13190

⁽⁷⁾ Available standard temperature ranges, see tables on page 3. For ranges not listed, please contact Baumer.